

Bracket for cable support system 330 mm 145 mm KTTS 300

Allgemeine Informationen

Products_Model	ET5400672
EAN	4013339182909
Producer	Niadax
Producer-Model	KTTS 300
Producer-Typ	KTTS 300
min. Order	
Class	Ausleger für Kabeltragsystem

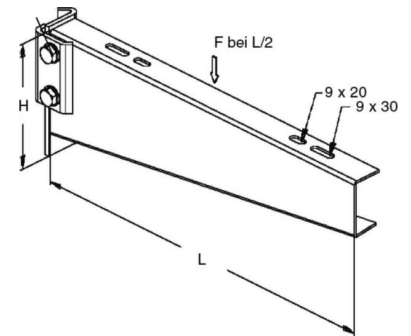

Technische Informationen

Länge	330mm
Höhe	145mm
Ausführung	
Winkel	90...90°
Geeignet für Funktionserhalt	
Werkstoff	
Rostfreier Stahl, gebeizt	
Werkstoffgüte	
Oberfläche	
Farbe	

[Bracket for cable support system 330 mm 145 mm KTTS 300 online kaufen](#)