

## T-head bolt for channels Steel HK 516/50

### Allgemeine Informationen

Products_Model	ET0469472
EAN	4013339124503
Producer	Niedax
Producer-Model	HK 516/50
Producer-Typ	HK 516/50
min. Order	
Class	Hammerkopfschraube

### Technische Informationen

Werkstoff	
Oberfläche	
Gewindemaß metrisch	
Länge	50mm
Kopfbreite	32.5mm
Geeignet für Montageschiene	

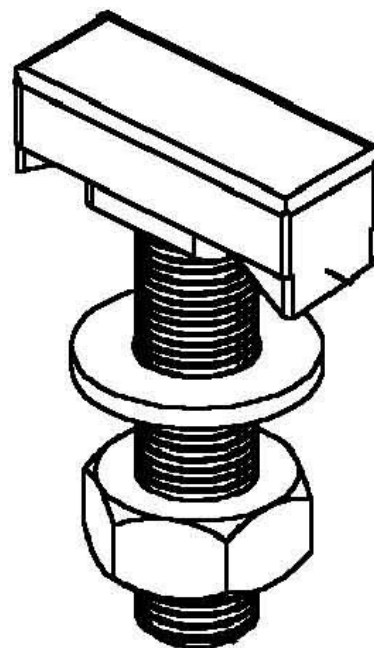

[T-head bolt for channels Steel HK 516/50 online kaufen](#)