

## Inner corner for installation duct 40 mm 40 mm LUIC 40.040 E3

### Allgemeine Informationen

Products_Model	ET5201067
EAN	4013339522781
Producer	Niadax
Producer-Model	LUIC 40.040 E3
Producer-Typ	LUIC 40.040 E3
min. Order	
Class	Inneneck für Leitungsführungskanal

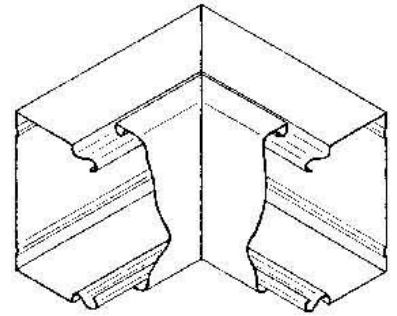

### Technische Informationen

Höhe	40mm
Breite	40mm
Ausführung	
Winkel	90...90°
Werkstoff	
Werkstoffgüte	
Halogenfrei	
Oberfläche	
Farbe	
Schutzfolie	
Befestigungsart	

[Inner corner for installation duct 40 mm 40 mm LUIC 40.040 E3 online kaufen](#)

