

Bracket for cable support system 340 mm 400 mm 206 mm KTTSS 300

Allgemeine Informationen

Products_Model	ET5401255
EAN	4013339183623
Producer	Niadax
Producer-Model	KTTSS 300
Producer-Typ	KTTSS 300
min. Order	
Class	Ausleger für Kabeltragsystem

Technische Informationen

Länge	340mm
Breite	400mm
Höhe	206mm
Ausführung	
Winkel	90...90°
Werkstoff	
Rostfreier Stahl, gebeizt	
Werkstoffgüte	
Oberfläche	
Farbe	

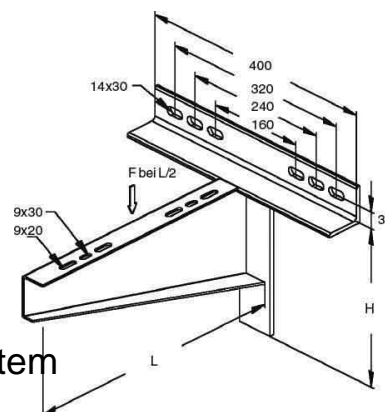

[Bracket for cable support system 340 mm 400 mm 206 mm KTTSS 300 online kaufen](#)