

## Accessories for control circuit devices Other XPEZ901

### Allgemeine Informationen

Products_Model	ET0747769
EAN	3389110600391
Producer	Schneider Electric
Producer-Model	XPEZ901
Producer-Typ	XPEZ901
min. Order	
Class	Zubehör für Befehlsgeräte

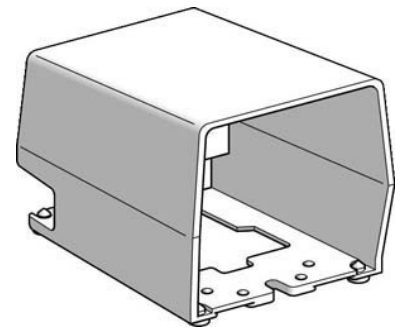

### Technische Informationen

Art des mechanischen Zubehörs:

[Accessories for control circuit devices Other XPEZ901 online kaufen](#)

