

## T-head bolt for channels Steel Other HM 410/30

### Allgemeine Informationen

Products_Model	ET0422455
EAN	4013339123209
Producer	Niedax
Producer-Model	HM 410/30
Producer-Typ	HM 410/30
min. Order	
Class	Hammerkopfschraube

### Technische Informationen

Werkstoff	
Werkstoffgüte	
Oberfläche	
Gewindemaß metrisch	
Länge	30mm
Kopfbreite	31mm
Geeignet für Montageschiene	

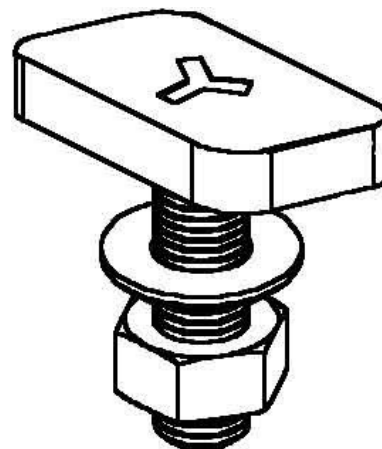

[T-head bolt for channels Steel Other HM 410/30 online kaufen](#)

