

T-head bolt for channels Steel Other HM 310/30

Allgemeine Informationen

Products_Model	ET0422453
EAN	4013339122202
Producer	Niedax
Producer-Model	HM 310/30
Producer-Typ	HM 310/30
min. Order	
Class	Hammerkopfschraube

Technische Informationen

Werkstoff	
Werkstoffgüte	
Oberfläche	
Gewindemaß metrisch	
Länge	30mm
Kopfbreite	23mm
Geeignet für Montageschiene	

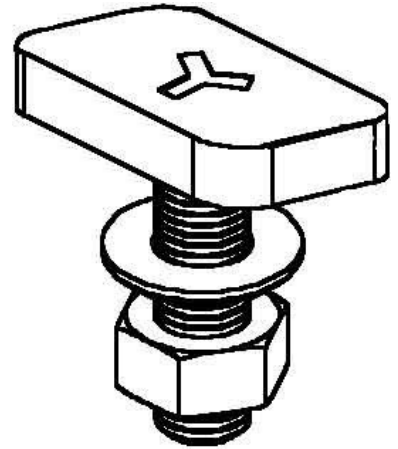

[T-head bolt for channels Steel Other HM 310/30 online kaufen](#)

